

The Jambo Registry  
www.82jambo.com

# 1979 Jeep® SPECIAL EQUIPMENT AND ACCESSORIES

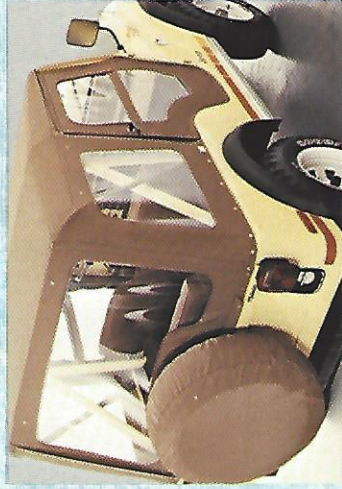
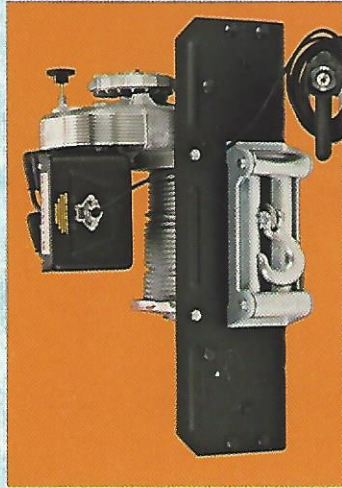
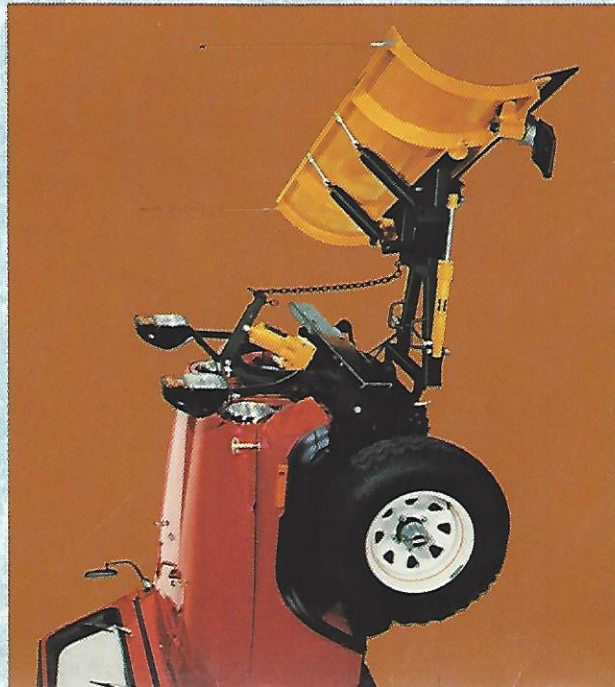

**SPECIAL EQUIPMENT AND ACCESSORIES...**  
Engineered to Jeep® Quality Specifications

OFF-ROAD RECREATION

WORK/UTILITY

COMFORT, APPEARANCE, LUXURY



# Make Your Jeep Vehicle Uniquely Yours

OFF ROAD/RECREATION	PAGE
Assist Handle (CJ's only)	7
Batteries (All models)	5
Boots (CJ's and Truck)	6
Brush-Guards (J-Series only)	6
Compass (All models)	7
Console (CJ's only)	10
Door Pocket Kit (CJ's only)	6
Draw Bar (CJ's only)	8
Driving Lights (All models)	7
Fender Extensions (CJ's only)	10
Fog Lights (All models)	7
"Grabit" Handle (CJ's and Truck)	9
Hitches (J-Series only)	8
Hitch Ball (All Jeep Vehicles)	8
Hubs (All models)	5
Hub Service Kits (All models)	5
Radiator Screen (CJ's only)	9
Roll Bars (CJ and Truck)	9
Roll Bar Padding (CJ's only)	9
Roller Fairlead Kit (All models)	4
Saddle Bags (CJ's only)	6
Search Light (All models)	7
Side Step (CJ's only)	10
Splash Guards (All models except Wagoneer)	10
Soft Tops (CJ only)	6
Swing-Out Spare Tire Carrier (CJ only)	10
Tire Covers (All models)	10
Tonneau (Truck only)	7
Tow Bar (CJ's only)	8
Winches (All models)	4
Winch Accessories (All models)	4
Winch Covers (All models)	4

WORK/UTILITY	PAGE
Air Overload Kit (All models)	13
Back-Up Alarm (All models)	13
Bumpers (Truck only)	14
Bumper Extensions (CJ's only)	14
Cabs (CJ's only)	15
Caps (Truck only)	15
Chip Guard (Truck only)	16
Engine Block Heater (All models)	16
Fire Extinguisher (All models)	16
Fuel Tank Skid Plate (J-Series only)	16
Helper Springs (Truck only)	13
Load Binder (Truck only)	14
Mini Spreader (Truck and CJ only)	12
Shocks, Heavy-Duty (All models)	13
Snatch 'um Strap (All models)	14
Snow Plows (All models)	12
Strobe Warning Light (All models)	13
Steering Stabilizer Kit (CJ only)	13
Truck Rails (Truck only)	16
Tow Hooks (CJ's only)	14
Truck Topper (Truck only)	15

COMFORT/APPEARANCE/ LUXURY	PAGE
Air Conditioning (All models)	18
Air Deflector (Cherokee and Wagoneer)	19
Bumper Guards (All models except CJ)	23
Carpeting (All models except Truck)	21
Chemicals, Appearance and Maintenance (All models)	23
Cruise Control (All models except CJ)	21
Decals (All models)	23
Door Edge Guards (All models except CJ)	23
Floor Mats (All models)	20
Heavy-Duty Cooling System (All models)	18
Highback Bucket Seats (CJ's only)	21
Litter Container/Tissue Dispenser (All models)	20
Luggage Carrier (All models except CJ)	19
Luggage Rack (Cherokee and Wagoneer only)	19
Mirrors (All models)	22
Power Steering/Power Brake Kits (All models)	23
Radio's (All models)	20
Rear Seat (CJ-5 only)	21
Slotted Wheels (All models)	22
Spare Wheel Lock (All models)	23
Sun Roof (CJ with Lexan top only)	19
Tire Carrier, Inside Spare (Cherokee and Wagoneer only)	21
Vent Shades (All models except CJ)	19

**NOTE:** The special equipment and accessories in this catalog have been indexed by function for your convenience. When equipping your Jeep vehicle, mix and match any items shown throughout the catalog (according to application information) to make your Jeep vehicle "uniquely yours."

## Jeep Country . . . Use It . . . Protect It!

Your Jeep vehicle is the key to a world of fun and adventure, but as you enter that world, remember, you are a guest. American Motors has long been active in the promotion of good conservation practices and the preservation of this

country's resources.

We hope that those who drive Jeep vehicles, or any recreational vehicle, will observe the laws of both man and nature, avoiding posted and restricted areas and respecting the habitats of

wildlife. By cooperating with each other, and with nature itself, recreational vehicle users can guarantee that the same wild beauty we enjoy today will always be here for us . . . and for our children.

JEEP® CJ, CHEROKEE, GOLDENEAGLE, QUADRA-TRAC® RENEGADE® and WAGONEER® are trademarks of Jeep Corporation.

American Motors (Canada) Limited is a licensed user.  
® Reg. TM



# Off-road recreation

Whether your Jeep vehicle is a CJ, Cherokee, Wagoneer, or Truck — you can equip it for fun on or off the road. In this section, you'll find Jeep equipment that will let you "build" your own recreational vehicle to fit your needs . . . and your whims. All Jeep Special Equipment and Accessories are designed to provide the kind of great performance, durability and reliability that you expect from a Jeep product.

	Page
Assist Handle (CJ's only) . . . . .	7
Batteries (All models) . . . . .	5
Boots (CJ's and Truck) . . . . .	6
Brush-Guards (J-Series only) . . . . .	6
Compass (All models) . . . . .	7
Console (CJ's only) . . . . .	10
Door Pocket Kit (CJ's only) . . . . .	6
Draw Bar (CJ's only) . . . . .	8
Driving Lights (All models) . . . . .	7
Fender Extensions (CJ's only) . . . . .	10
Fog Lights (All models) . . . . .	7
"Grabit" Handle (CJ's and Truck) . . . . .	9
Hitches (J-Series only) . . . . .	8
Hitch Ball (All Jeep Vehicles) . . . . .	8
Hubs (All models) . . . . .	5
Hub Service Kits (All models) . . . . .	5
Radiator Screen (CJ's only) . . . . .	9
Roll Bars (CJ and Truck) . . . . .	9
Roll Bar Padding (CJ's only) . . . . .	9
Roller Fairlead Kit (All models) . . . . .	4
Saddle Bags (CJ's only) . . . . .	6
Search Light (All models) . . . . .	7
Side Step (CJ's only) . . . . .	10
Splash Guards (All models except Wagoneer) . . . . .	10
Soft Tops (CJ only) . . . . .	6
Swing-Out Spare Tire Carrier (CJ only) . . . . .	10
Tire Covers (All models) . . . . .	10
Tonneau (Truck only) . . . . .	7
Tow Bar (CJ's only) . . . . .	8
Winches (All models) . . . . .	4
Winch Accessories (All models) . . . . .	4
Winch Covers (All models) . . . . .	4

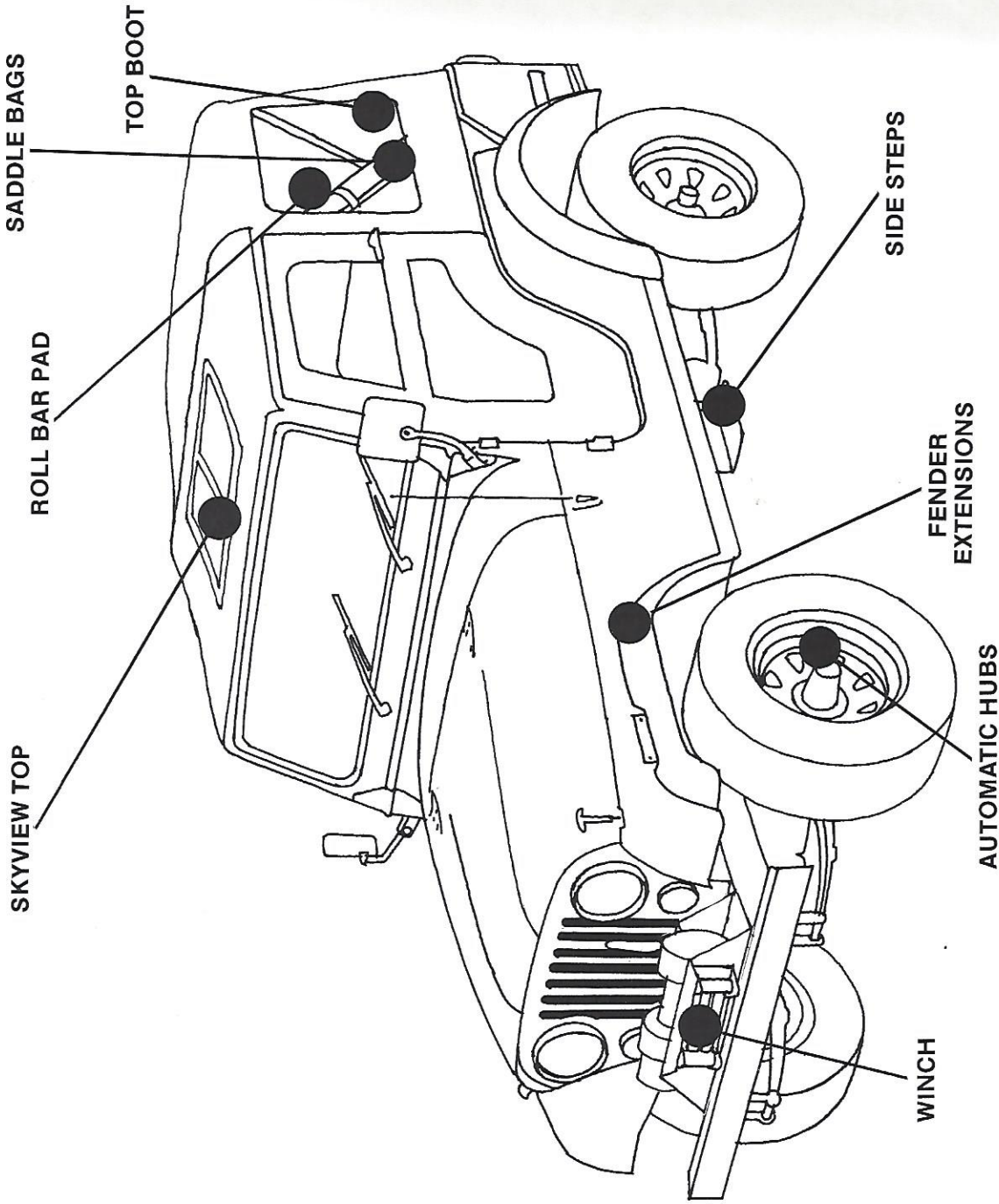

Special Equipment and Accessories . . .  
 Engineered to Jeep® Quality Specifications



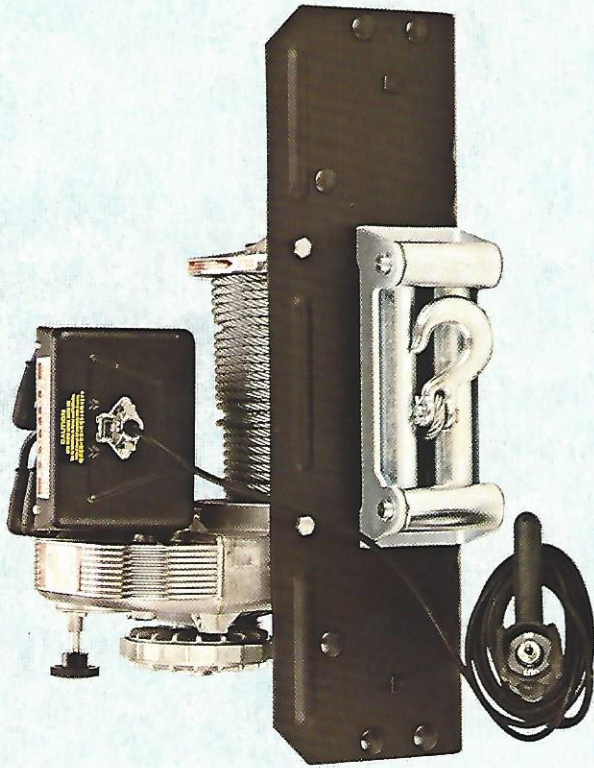

**WARN ELECTRIC WINCH**

Your Jeep vehicle can take you just about anywhere. But that doesn't mean you can't get stuck. When that happens, your Warn Winch can save the day by pulling you (or someone else) out with up to 8,000 pounds of pull on a single line. The 12-volt electric motor runs even when your engine won't. This Warn Winch also features a manual clutch for free-spooling the wire cable, a reversible motor for Power-in/Power-out control, self-locking disc-type brake, and a maintenance-free gear case. Winch comes complete with either hawse-type or roller fairlead, 150 feet of 5/16" galvanized aircraft wire cable with hook, and remote hand control with 12 foot lead. Fits all years and models of Jeep vehicles. (Mounting kits must be ordered separately.)



**RAMSEY ELECTRIC WINCH**

Ramsey model 2000/2001 Electric Front Mount Winch packages are specifically designed so that the operator can be in control at all times. Ramsey winches fea-

ture up to 8,000 lbs. capacity and are powered both in and out. A manual clutch permits free wire cable spooling for added convenience. The winch features a self-locking worm and gear (automatic braking), covered drum flanges to prevent wire cable fouling, and two types of fairlead cable guides. Model 2000 includes a hawse-type fairlead while Model 2001 includes a four-way roller. Each winch package comes complete with 150 ft. of 5/16" galvanized, aircraft-type cable with replaceable clevis hook, battery cable and connectors, and a three-way remote control. Will fit all Jeep vehicles with appropriate Mounting Kit.

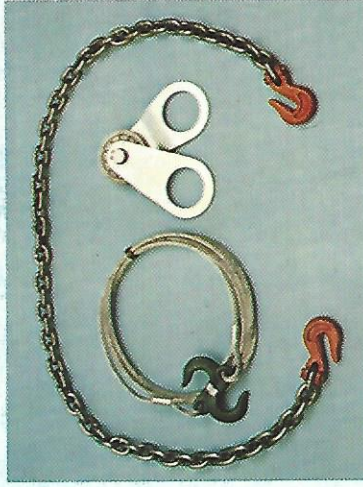

**WINCH ACCESSORIES**

With the right accessories you can tackle all kinds of jobs with your winch. The 6 foot choker chain lets you anchor your winch line around large objects. For towing other vehicles, the 15 foot 5/16" galvanized aircraft wire tow cable will handle the job. The heavy-duty snatch block lets you double the pulling power of your winch by running double line pulls.

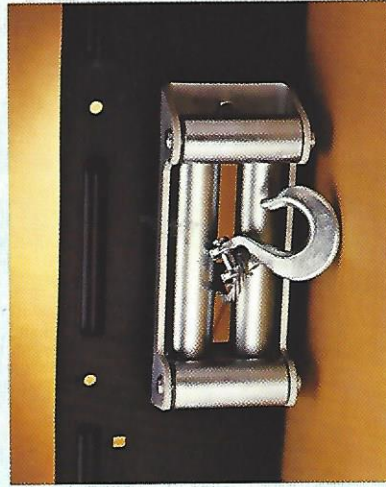

**ROLLER FAIRLEAD KIT**

Simple bolt on installation. Cadmium plated housing with solid steel rollers for heavy duty use. Adds to cable life by eliminating cable chafing and allows winch to be used at more extreme angles for more on site versatility. Available for Warn Winch only.



**PORTABLE ELECTRIC WINCH**

For instant installation, just place it on your front or rear trailer hitch ball with a hitch ball adapter. Features compact 8" x 11" x 10" size, strong housing, improved braking control for spooling out and a hand crank for emergency use. Winch has 3,000 lb. rated pulling power and includes 50 ft. of 3/16" cable and hook. Simple plug-in battery cable is included.



**WINCH COVER**

Waterproof, impact-resistant fabric cover protects your Warn winch from the elements and adds a streamlined look to the front of your Jeep. Available for Warn Winch only.





place  
trailer  
adapt-  
11" x  
3, im-  
l for  
crank  
h has  
ower  
3/16"  
lug-in



stant  
Warn  
to the  
ble for

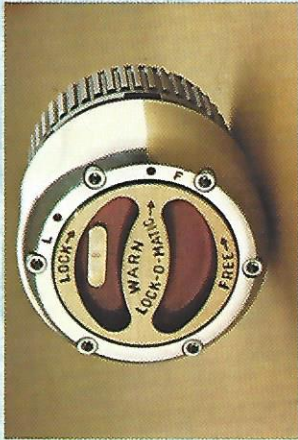
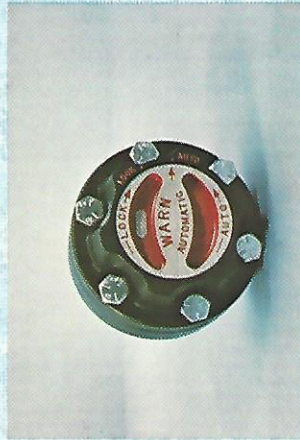

### AUTOMATIC HUBS

Warn Automatic Hubs work just like Warn Manual Hubs, but with one big time saving difference. With Automatic Hubs, just shift your transfer case into four-wheel drive and your hubs will *automatically* engage the front axle and drive train. You never have to get out of your Jeep vehicle or remember to switch the hub control dials. Available on all new Jeep vehicles and for many models of early Jeep vehicles, except those equipped with Quadra-Trac.<sup>®</sup>

### MANUAL HUBS

When you shift your Jeep vehicle into two-wheel drive, your front axle and gear train keep on turning. That not only causes extra wear and drag, it also eats up gas. What's the answer? Warn Hubs. Simply turn the hub dial and your front wheels will turn freely when you're in two-wheel drive. When you're ready to go four-wheelin', just turn the hub dials back and you've got normal four-wheel traction and power. Available for all years of Jeep vehicles, except those with Quadra-Trac.<sup>®</sup>

### HUB SERVICE KIT

Although Warn Hubs don't normally need servicing, you do need to remove them when you work on your brakes or bearings. When that time comes, this kit can save plenty of time by giving you all the gaskets, o-rings and washers needed to reinstall one set of hubs.

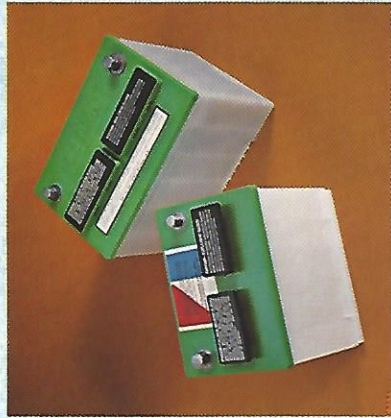
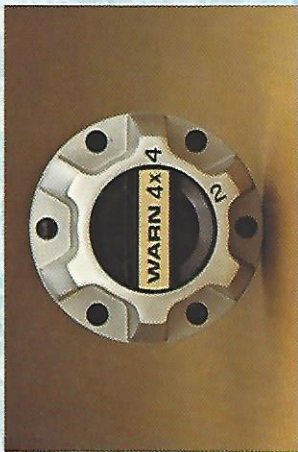

### LIMITED MAINTENANCE BATTERIES

Factory approved by Jeep Corporation for all Jeep vehicles, these batteries are rated "required limited maintenance." Thin, tough Polypropylene containers allow more room for plates and electrolyte . . . more starting power. Flame-retardant vent caps minimize evaporation.

**NEW** A battery line of 45-54 AMP. For select 1979 Jeep vehicles featuring a similar operating capacity in a smaller, lighter weight designed battery . . . adding to vehicle weight/reduction for better performance.

And also available are 50 to 80 AMP size for select '79 and past model application.

Warranties (pro rata) range from 42 to 60 months. Check your Owner's Manual for specifications. (In Canada, specifications and features may vary).

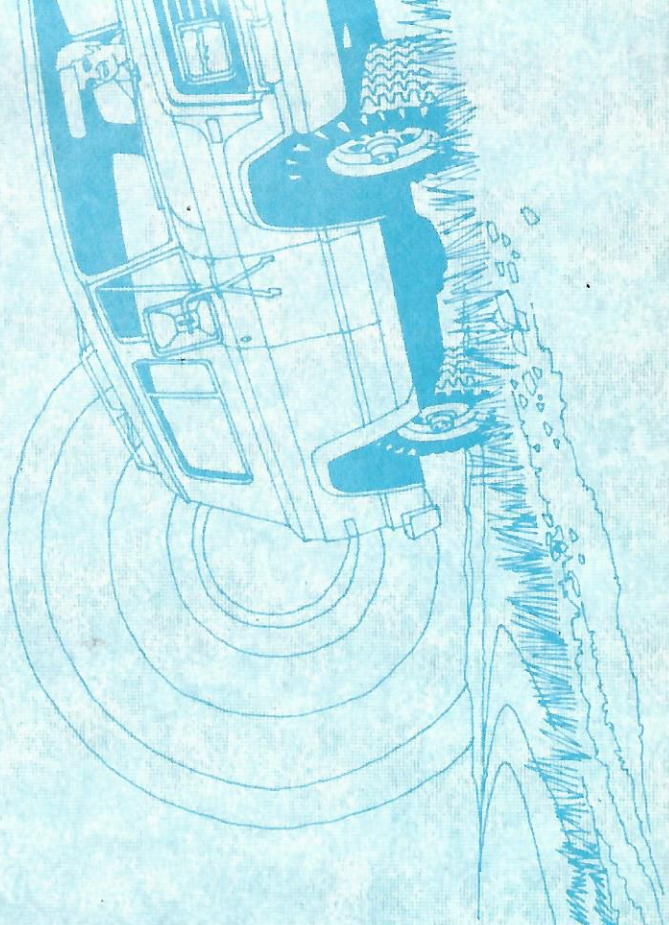





#### SAFARI SOFT TOP

The Safari Soft Top has been redesigned to provide greater rear visibility for 1979. This rugged top features heat-sealed seams; heavy, clear vinyl windows that resist cracking or clouding and foam dust seals. The sturdy, 3/8" steel door frames have cadmium or zinc plated hardware, extra reinforced snaps and attached curtain straps. The Safari Top stows neatly between the rear seat and the spare tire when not in use. Available for all CJ models in a choice of black, white, blue or tan.



#### SKYVIEWER SOFT TOP

This soft top offers the same rugged construction and features as the Safari Soft Top with the addition of an 18" x 30" roof window. The roof window is made of vinyl which resists cracking and clouding and is tinted to reduce glare and heat. Available in black, white, blue and tan for all CJ's.

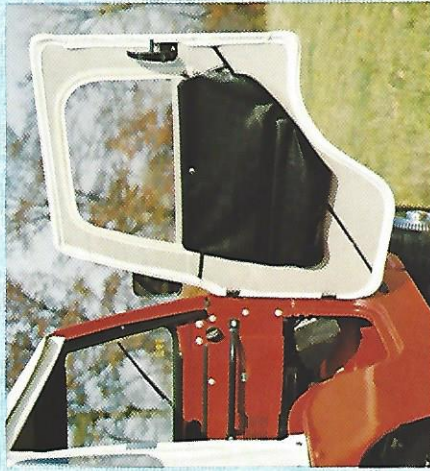

#### DOOR POCKET KIT

Specially designed for soft tops, this door pocket kit provides a handy place to keep small articles like maps and sunglasses, camera or other breakables without the expense of losing passenger area. Fits all CJ models, available in black only.



#### TOP BOOT

You can protect your soft top and vinyl windows while in a rolled down position or when stored. Give your CJ a finished look with this handsome top boot. Available in colors to complement your soft top.

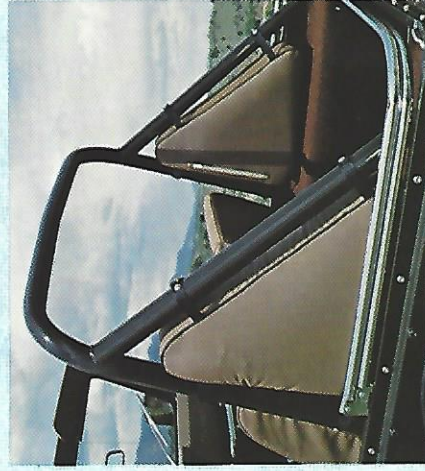

#### SADDLE BAGS

Durable vinyl saddle bags help you tote your gear on or off your Jeep CJ. Snaps on the roll bar, out of the way, providing extra storage in the vehicle. They can be easily removed allowing you to take tools, camp gear, clothes, etc. with you. Available in black, white, tan or blue for all CJ models with Jeep roll bar.



#### BRUSH GUARD

Protect the front of your Jeep vehicle when traveling off-the-road, add a brush guard to your Cherokee or Truck (not available for Wagoneer or CJ). Constructed of heavy gauge steel, this rugged brush guard is mounted securely to the bumper and frame, in front of the grill and headlights.





**COMPASS**

To help you find your way, on or off the road, this compass kit is available for any Jeep vehicle. Features day/night illumination and can be mounted anywhere. The kit also includes compensating magnets to offset your vehicle's own magnetic field and give you correct compass readings.

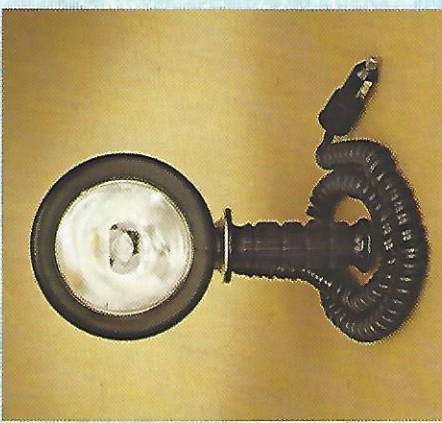

**HAND HELD SEARCH LIGHT**

New for 1979, the hand held search light is handy, whether you're looking for wildlife, or looking for a road sign. Features include a twelve-foot, heavy-duty coiled cord and a plug that fits any cigarette lighter. This unit is designed to deliver quartz light brilliance and long life at a reasonable cost.

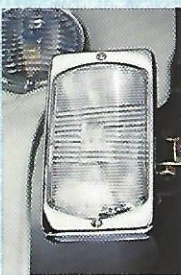

**FOG LIGHTS\***

For your safety in bad weather driving, add a Cibie fog light featuring iodine halogen lamp. It allows excellent light penetration in fog, rain, and snow — up to 500 feet with a wide angle 180° beam pattern. When not in use, the Cibie fog light adds a rugged look to your Jeep vehicle.



**DRIVING LIGHTS\***

Don't over drive your headlights. With these Cibie® Iodine Halogen driving lights . . . you won't. These lights will illuminate an object up to 5,000 ft. ahead. Tough good looking appearance. Available for front bumper mount on all Jeep vehicles. An optional CJ light bar is available. The truck roll bar has predrilled mounting points.

**LIGHT BAR (not shown)**

Windshield mounted CJ light bar gives that serious off-road look without interfering with top installation or windshield pivot. Sturdy square steel tubing securely mounts all driving lamps.

\*Local restrictions should be consulted before installation of any high-intensity lights.

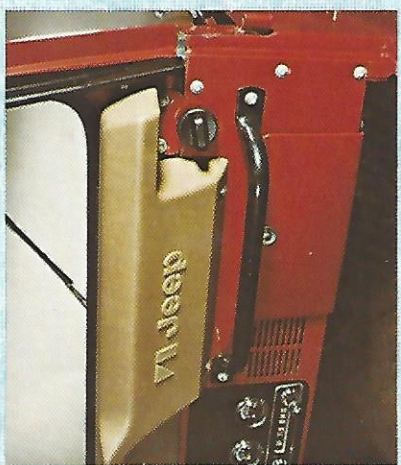

**ASSIST HANDLE**

This assist handle helps your passenger hang on over rough terrain and also provides a convenient tie-down for extra equipment and containers. Available for installation at any of several spots on Jeep CJ models.



**TONNEAU COVER**

This is a styling accent that gives your Pickup box a sleek, streamlined appearance. Constructed of tough vinyl-coated fabric, the cover snaps on with ease. Available in black or white for either 7 ft. or 8 ft. Townside boxes.



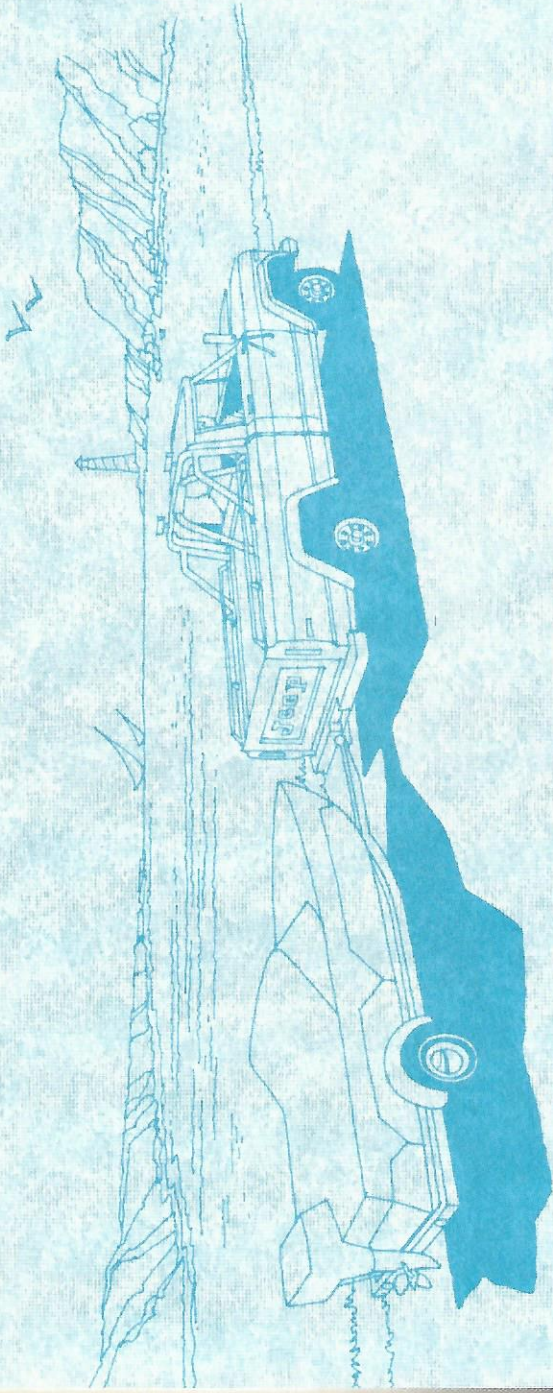

#### **DRAW BAR**

Equip your CJ for trailer hauling with this specially designed draw bar which has the equivalent strength of a Class I Hitch system. The draw bar mounts in the rear and requires heavy duty springs and shock absorbers. Available on all CJ models.

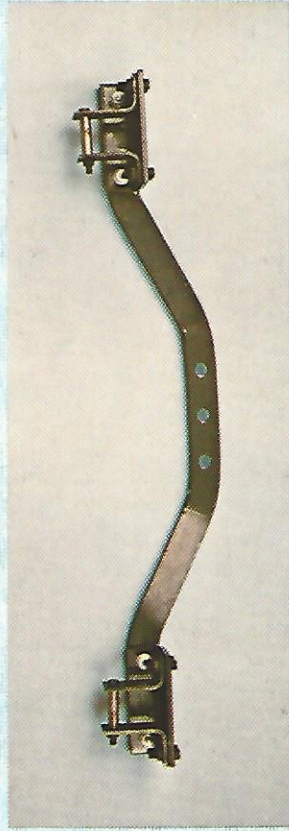

#### **TOW BAR**

This is a great item for those who want to tow their CJ to where the action is. The CJ Tow Bar allows you to hitch your CJ to either a 1-7/8" or 2" diameter hitch ball. It features heavy-duty steel construction and pivots out of the way with a positive latch to lock it in place. For all CJ's.



#### **CLASS II HITCH**

Here's a hitch that's ideal for boat trailers, tent trailers, utility or tandem axle trailers up to 3,500 lbs. and with tongue weights of up to 350 lbs. It features heavy-duty construction from cold drawn steel with a 3/4" pre-drilled tongue for a Class II ball hitch. This hitch requires heavy duty rear springs and shock absorbers. Available for all Jeep vehicles.

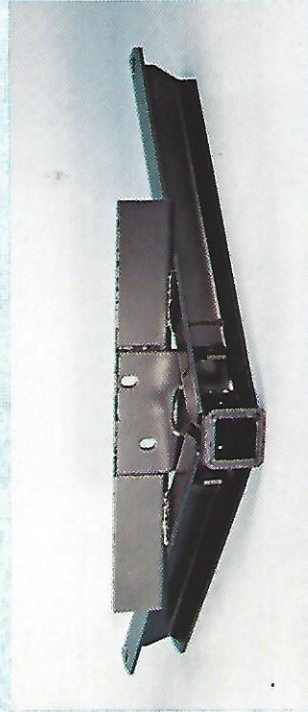

#### **CLASS III HITCH**

For applications that require big towing capacity, this equalizing hitch of all-welded construction is available for Jeep Wagoneer and Cherokee. Specially designed, it provides improved weight distribution with trailer loads up to 7,500 lbs., when used with equalizing equipment. Heavy duty rear springs and shocks are required with this hitch.



#### **HITCH BALLS**

For secure trailering, these hitch balls are made of forged and machined cold drawn steel and finished in chrome. 3/4" shank is available, designed for trailer weights up to 3,500 lbs. and solid one inch shank diameter. 1-7/8" and 2" sizes are available for Class II hitch applications. For all Jeep vehicles.



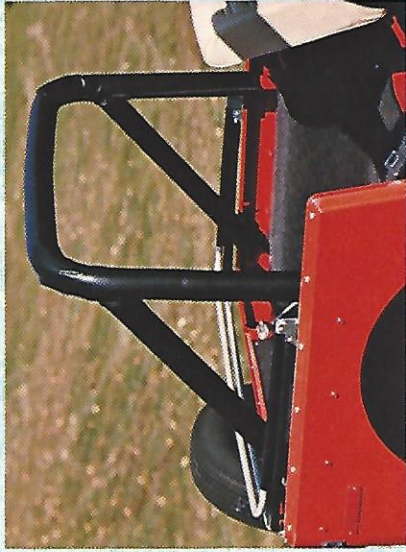

**ROLL BAR PADDING**

These three piece roll bar pads add a custom look and a soft touch to any CJ Roll Bar. Made of thick, molded foam rubber with a tough vinyl cover that zips over the roll bar. For CJ Roll Bars only.

**ROLL BAR — CJ**

CJ Roll Bars are constructed of two-inch outside diameter, 11-gauge tubular steel with electric feed welds for greater strength and durability. The roll bar attaches at 16 points for extra security, but doesn't interfere with passengers or cargo. Fits under all approved soft tops and cabs on CJ models.

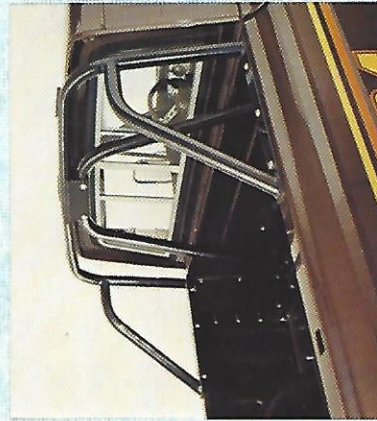
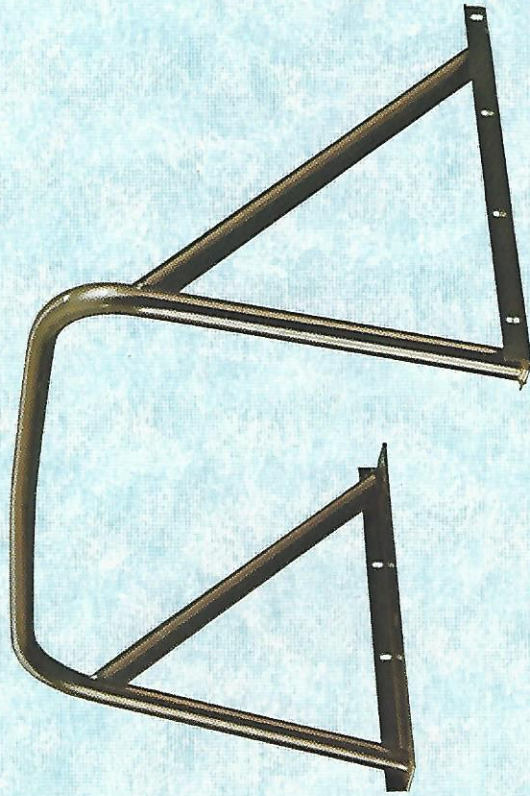

**ROLL BARS — TRUCKS**

These specially designed roll bars are available for your Jeep Truck. Mounted behind the pickup cab, these two-inch outside diameter roll bars are of all electric weld construction. Securely attached at 16 points, they leave the cargo bed free for full capacity loads. Available for Jeep Pickups only. (Cannot be used with Truck Rails.)

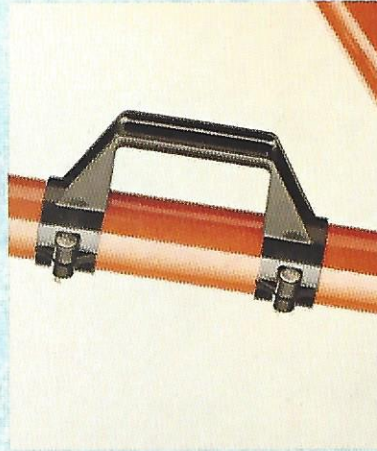

**"GRABIT" HANDLE**

A really helpful little option that helps rear seat passengers get in and out and keeps them in when the going gets tough. It attaches in seconds to any Jeep roll bar and is of heavy-duty black plastic construction. Available on all models with roll bar.



**RADIATOR SCREEN**

This rugged and specially-designed screen will protect your cooling system from flying debris or possible hazards on, or off, the road. It mounts easily to the radiator grill.





**SWING-OUT SPARE TIRE CARRIER**

The Swing-Out Spare Tire Carrier makes access to the rear of your CJ even easier. It features heavy-duty construction, with excellent weight distribution and a positive-closing latch. This carrier doesn't interfere with the soft top in the "down" position. Available on all CJ models.

**TIRE COVERS**

These new tire covers from Jeep cover up your spare and dress up any Jeep vehicle. Available in shades to match all Jeep tops in a choice of solid colors. Also available are heavy-duty vinyl covers featuring the Eagle design which can be specially imprinted.

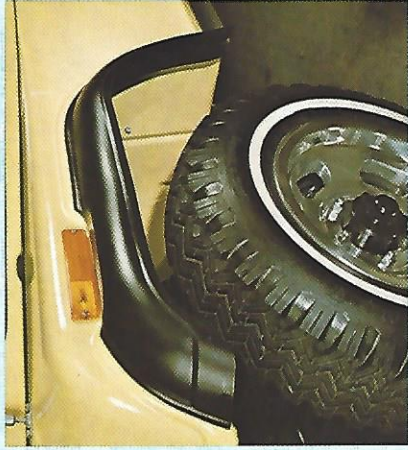
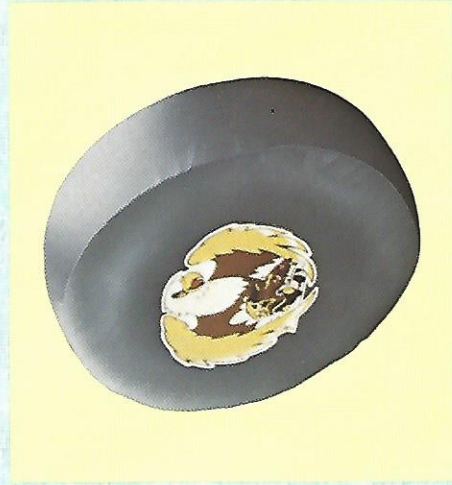

**FENDER EXTENSIONS**

Protect your Jeep body from sticks, stones and other flying debris with these high-density plastic fender extensions. They conform to fender contours and are easy to install. Besides protection, fender extensions add a great look to your Jeep CJ. Available in a set of four for Jeep CJ.

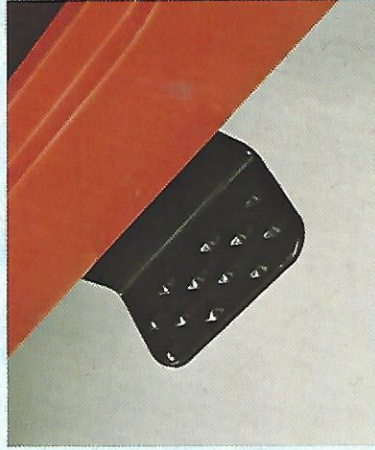

**SIDE STEPS**

Side Steps give you an "easy out", not to mention an "easy in". They're a must for convenience. Easy-to-install, bolt on steps are available in pairs. Durable and sturdy all-steel construction. Available only on CJ.



**CONSOLE**

This handy console lets you carry cold beverages in safety, even off the road. Features a drain tube that carries condensation and water through the floor of the vehicle. Designed to fit the floor contours of CJ-5 or CJ-7 models, it's easy to install and features a lockable lid so it can double as a locker for valuables.



**SPLASH GUARDS**

Jeep Splash Guards combine distinctive styling with practicality. Helps prevent stones, mud and other road debris from harming your Jeep body. Set of two. (Not available on Wagoneer).



# Work/Utility

Specialize your Jeep Truck, Cherokee, Wagoneer or CJ with rugged Jeep Accessories and Special Equipment — equipment designed to meet *your* needs. Whether it's for full- or part-time use, you can customize your Jeep workhorse to handle the jobs you need done. And, all Accessories and Special Equipment featured in this book are *fully* warranted by Jeep Corporation\*. If it isn't good, we won't put it on a Jeep vehicle.

	Page
Air Overload Kit (All models) . . . . .	13
Back-Up Alarm (All models) . . . . .	13
Bumpers (Truck only) . . . . .	14
Bumper Extensions (CJ's only) . . . . .	14
Cabs (CJ's only) . . . . .	15
Caps (Truck only) . . . . .	15
Chip Guard (Truck only) . . . . .	16
Engine Block Heater (All models) . . . . .	16
Fire Extinguisher (All models) . . . . .	16
Fuel Tank Skid Plate (J-Series only) . . . . .	16
Helper Springs (Truck only) . . . . .	13
Load Binder (Truck only) . . . . .	14
Mini Spreader (Truck and CJ only) . . . . .	12
Shocks, Heavy-Duty (All models) . . . . .	13
Snatchum Strap (All models) . . . . .	14
Snow Plows (All models) . . . . .	12
Strobe Warning Light (All models) . . . . .	13
Steering Stabilizer Kit (CJ only) . . . . .	13
Truck Rails (Truck only) . . . . .	16
Tow Hooks (CJ's only) . . . . .	14
Truck Topper (Truck only) . . . . .	15

\*In Canada, American Motors (Canada) Limited.

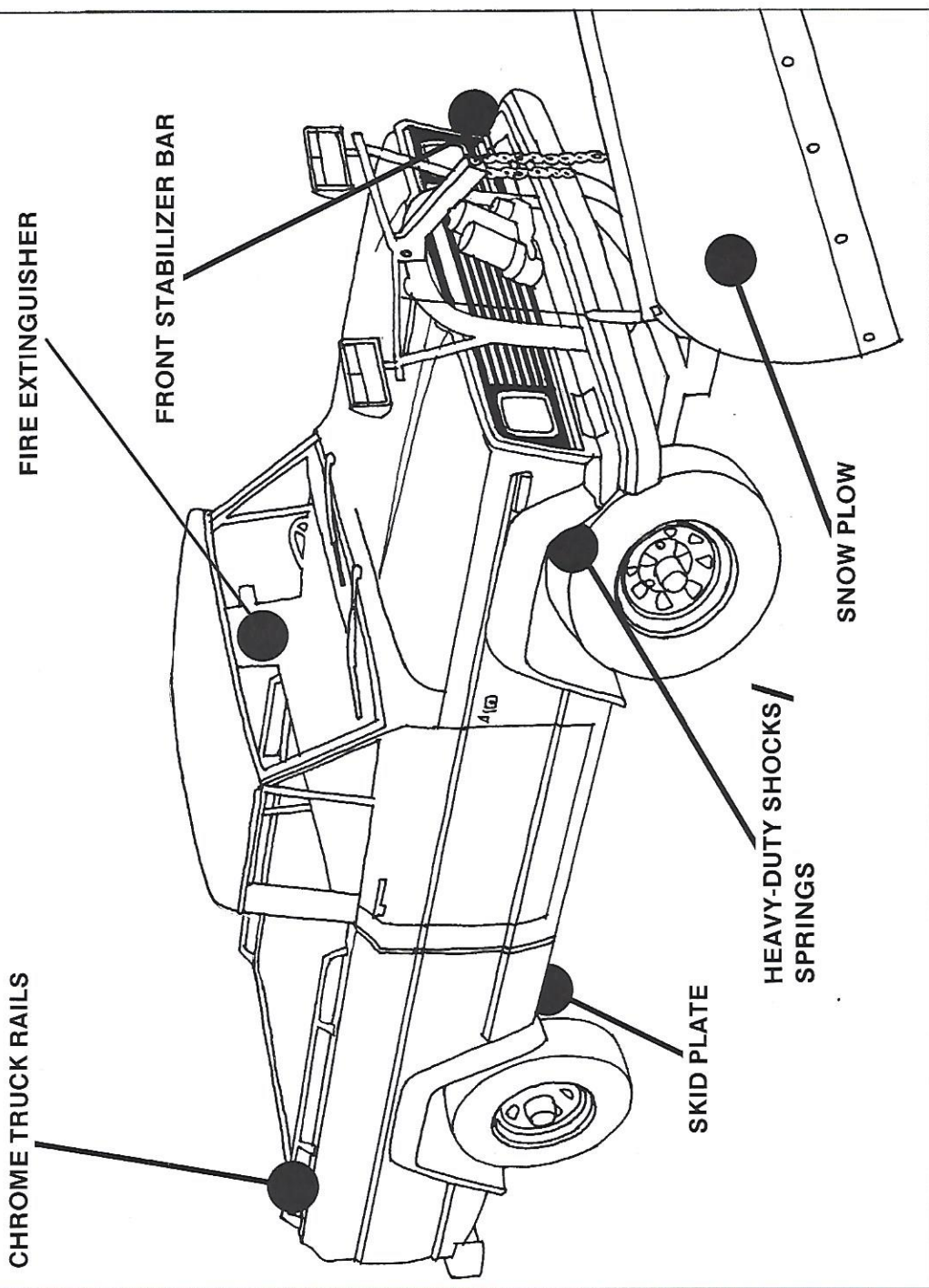

Special Equipment and Accessories . . .  
 Engineered to Jeep® Quality Specifications





**Safety Features include:** Cone Trip Springs which release and pivot the plow forward if it hits an unseen obstruction. And, an Angling Cross-Over Relief system reverses the plow angle if its forward edge hits a side obstruction. These two systems provide maximum protection for your Jeep vehicle and plow mountings.

**Mandatory and Recommended Equipment**

Heavy-duty front and rear springs and shocks, or the Air Bag type overload kit and lights are required on all CJ models equipped with a snow plow. Cherokee, Wagoneer and Pickup models require heavy-duty front springs, heavy duty cooling, dual light assembly, and D range Suburbanite, All Service or X-Grip tires. In addition, for all plows equipped with electric lift and control units a heavy-duty battery and alternator are recommended.

**JEOP SNOW PLOWS . . .** Take advantage of this added source of income during snow months. Designed for fast and efficient operation.

Your Jeep dealer has the right snow plow for every Jeep vehicle. Each snow plow mount is custom designed to match each Jeep vehicle -- providing the best weight distribution and maximum pushing power for every unit.

The snow plows are made of high-strength, low alloy steel moldboard reinforced with angle iron to make them lightweight and durable. A high carbon steel cutting edge made of 6" special grader blade steel gives your snow plow greater service life. And, the specially-developed, high-visibility Sno-Flo® finish yellow paint provides fast, smooth snow-rolling action.



The Electro-Touch power angling feature can change the angle of the blade from 30 degrees left to 30 degrees right in just three seconds. And, the entire unit is factory assembled, filled, sealed and tested for Jeep quality.

At a flick of the conveniently located controls, the Electric/Hydraulic power pack feature can raise or lower the plow in just two seconds. The Electric/Hydraulic power pack can be readily adapted to any 12-volt system.

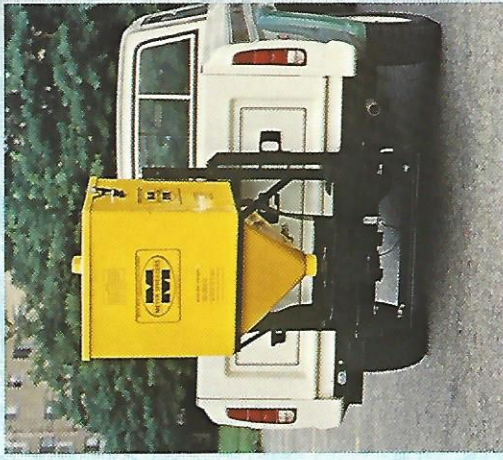

**MINI SPREADER**

A lightweight, 600 lb. capacity, polyethylene Mini Spreader is available on all Jeep Pickup and CJ models. Adjustable spread control lets you spread dry rock salt in a path from 3 to 30 feet. Side mounted spare and draw bar are required for installation on Jeep Truck and CJ models.





### HEAVY DUTY SHOCKS

Trail Tamer Heavy Duty Shocks provide better control both on the job and off-road and are designed for longer service life. Shock features include a resistance welded upper mounting to withstand 5,000 lbs. of force, multi-lip seal for low friction and wear, double the piston damping area and an arc-welded lower mount for maximum strength. Available on all late model Jeep vehicles.

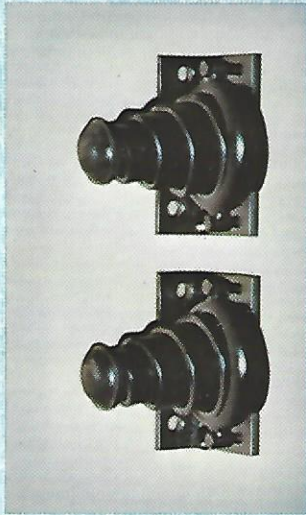

### HELPER SPRINGS

These factory designed heavy duty springs increase your load carrying capacity with greater safety, and help prevent rear end sag. These springs also improve traction and stability. Available for Pickup models only.



### STEERING STABILIZER KIT

The Jeep engineered Steering Stabilizer Kit improves driver control in both on- and off-road conditions. The steering stabilizer dampens the shimmy of loose front ends to improve steerability. Heavy steel tube construction with airplane-type hydraulic fluid provides quick response in all temperatures. The Kit comes complete with steel mounting brackets and all necessary hardware. Fits all CJ-5 vehicles.

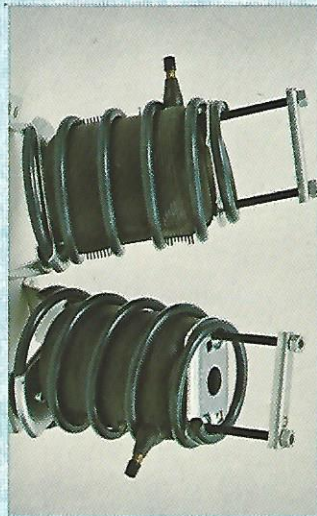

### AIR OVERLOAD KIT

Air Overloads provide increased spring rate capacity for vehicles equipped with a standard suspension, and cushion your springs for a safer, more comfortable ride. Inflated with air, they increase traction, help prevent sway on curves, and help reduce dipping during hard stops. Air Overloads are available in sets of two for all Jeep vehicles.



### BACK-UP ALARM

How do you warn people when you're backing up? With a Jeep .85 decible electronic back-up alarm. This fully-transistorized alarm weighs only 4 ounces and draws less than one amp. of power. The 12 volt alarm is enclosed in a weatherproof case for greater durability and is available on all Jeep vehicles.



### STROBE WARNING LIGHT

This high-density, 360 degree strobe light really lets people know you're there. And, it draws less power than most conventional revolving lights. An optional magnetic base and remote plug-in provide for portability and temporary mounting, and a tough Lexan® lens resists cracks and breakage.

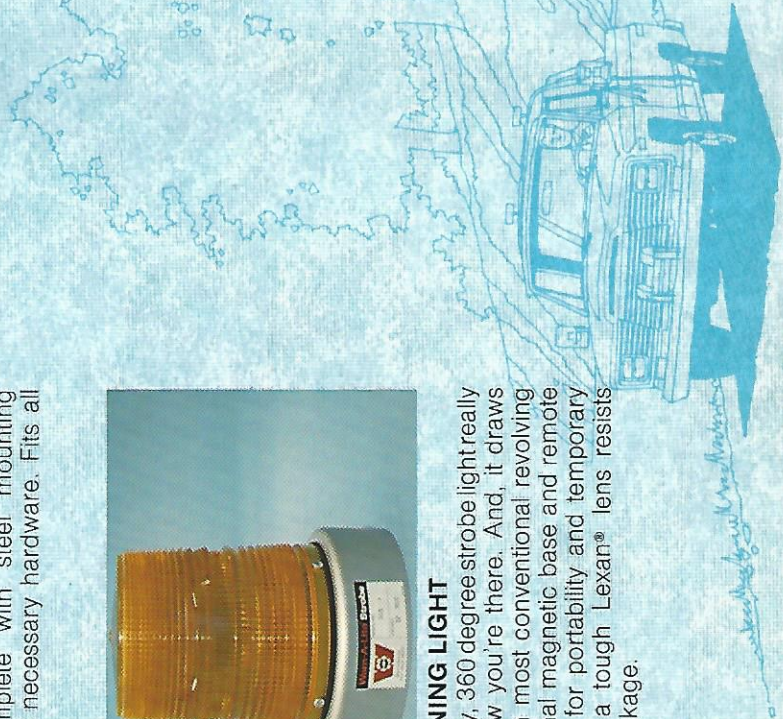





**EPOXY FINISH BUMPER**

Give your Pickup a custom look with an Epoxy Finished Bumper. This formed bumper also provides greater strength and collision damage protection. End caps wrap around corners of vehicle for further protection. Recessed draw bar is reinforced with 1" thick steel for greater pulling capacity and longer life. A built-in 6" step with non-skid strips provides safer footing, wet or dry. Baked epoxy finish guards against rust and corrosion. Available for Jeep trucks.



**CHROME-PLATED BUMPER**

Add more style to your Pickup with this one-piece, heavy, nickel-plated, rear bumper with a built-in stepping surface. It's actually a hitch, fabricated with provisions for a hitch ball which resists "ovaling" and thus provides greater pulling power. The Chrome-Plated Bumper is free from corrosive-prone welds and seams.

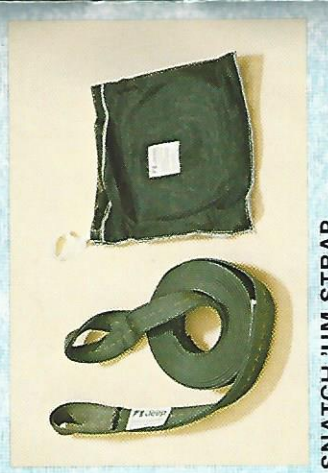

**SNATCH 'UM STRAP**

Just the thing to help free badly stuck vehicles. Improved 30 ft. Snatch 'Um Strap provides 20,000 lbs. of strength and safety. Attaches directly to your trailer hitch or frame member. Complete with handy carrying bag.

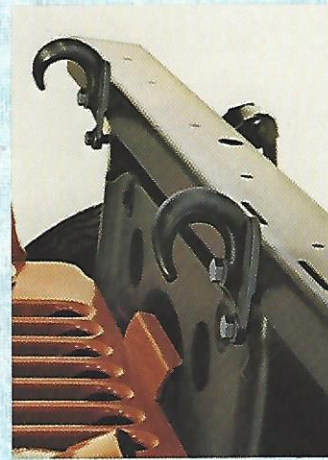

**TOW HOOKS**

Sturdy construction Jeep Tow Hooks are perfect for towing or being towed. Designed to get the job done faster, these tow hooks are available in sets of two for all CJ models.



**LOAD BINDER**

Jeep Load Binder, designed to prevent costly cargo and truck body damage due to shifting cargo. Can be easily installed in all Jeep Pickups with side rails. The chain has a vinyl sleeve to protect cargo, and the ratchet tightening device insures secure, quick tie down — reducing loading time. The Load Binder all-steel fabrication provides for years of use.

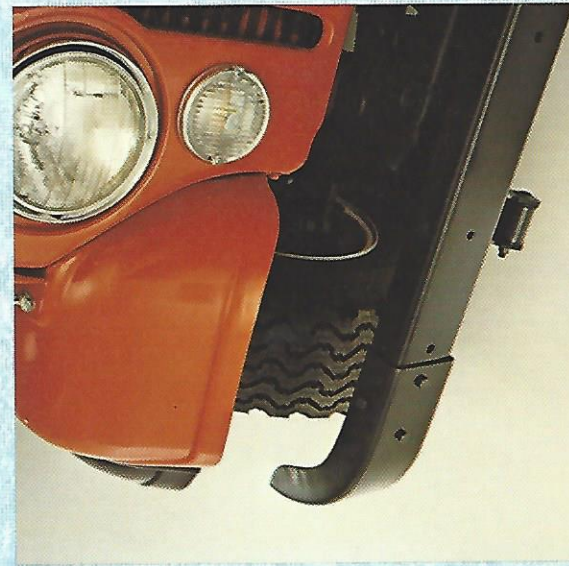

**BUMPER EXTENSIONS**

Bolt-on Bumper Extensions — for front bumpers — provide additional protection for your CJ. The Bumper Extensions are made of strong forged steel, and are painted black to match the original equipment bumper.



### DELUXE M3 CAB

With this deluxe all-metal cab your Jeep CJ-5 is ready for all kinds of weather. This cab features a finished headlining with dome light, crank and gear-operated windows that lower completely into the door panel, and full tailgate freedom for easy loading and unloading. Wide angle rear vision is provided for improved handling in traffic, and chrome plated locking door handles complete your security. Deluxe M3 Cabs are available only on CJ-5 models equipped with a front stabilizer bar.



### STANDARD M3 CAB

The Standard M3 metal cab protects from rain, snow, dust and cold. Design features rounded corners one-piece roof and a high-luster, durable finish. Locking chrome door and liftgate handles provide easy access while providing a measure of security. Requires front stabilizer bar installation. Not available for CJ-7.



### STANDARD CAB WITH VERTICAL REAR DOOR (Inset)

The Standard metal cab is also available with a full-length vertical rear door for easy access to the rear compartment on your CJ-5. Not available on CJ-7 models, this cab includes the same standard cab features and requires a front stabilizer bar.

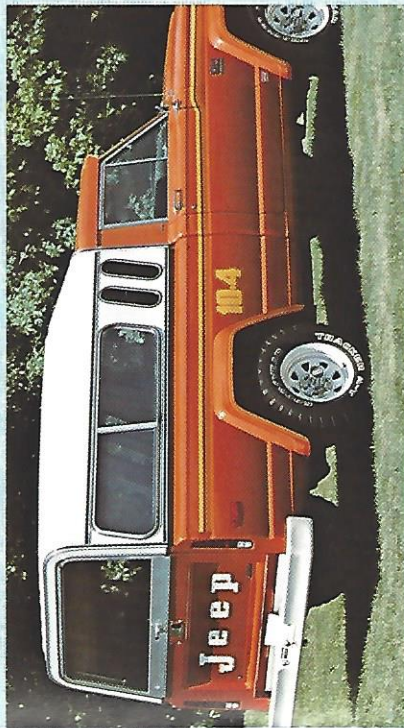

### TRUCK CAP

Newly designed in 1979, this sturdy cap provides needed all-weather protection for your cargo. Features reinforced light weight construction, tinted safety glass, lockable sliding side window and rear door. Available in white, with optional sliding front window. This superb quality cap will fit all Jeep Trucks.



### TRUCK TOPPER

This convertible fabric Truck Topper adds all weather protection for your cargo, and provides plenty of headroom (up to 45") when used in camping situations. Zippered roll-up curtains (with ventilation screens) provide for full width and height loading access. And, the Truck Topper folds out of the way when you need an open box. The Truck Topper comes in white only and is available on 7 and 8 ft. Townside boxes.



### HALF CAB

This sturdy Half Cab keeps the drivers compartment wind and weather free while leaving the rear compartment open for carrying tools and equipment. The CJ-5 Half Cab is made of rugged design and all metal construction with a durable, high-luster finish. A front stabilizer bar is required. Available only on CJ-5 models.





### JEEP FIRE EXTINGUISHER (For all type fires)

Fires come in all sizes but only 3 basic types Class A B C. Class A fires are those involving paper, cloth, wood, upholstery and other ordinary combustibles. Class B fires involve gasoline, oil, grease and other flammable liquids. Water should not be used on this type of fire. Class C fires involve electrical equipment and here again water should not be used because of danger of severe electrical shock. Be smart not sorry. Protect you and yours with the Jeep Vehicle Fire Extinguisher.



### FUEL TANK SKID PLATE

A must for off-road use. This Fuel Tank Skid Plate adds extra protection for the gas tank. With easy bolt-on installation. Skid Plate is available for all Jeep vehicles. (Standard on Cj.)

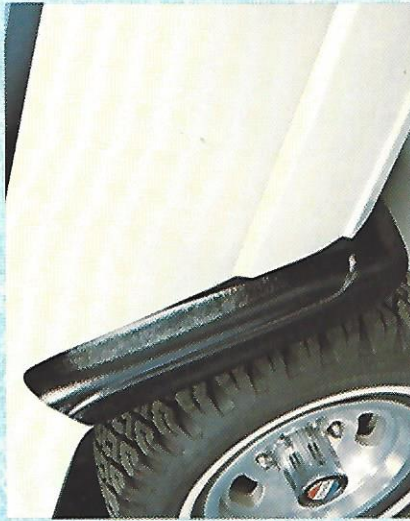

### CHIP GUARDS

Designed for Jeep Pickups with Townside boxes. These high density, molded plastic Chip Guards protect against stone and gravel chips, sand blasts and road debris. Conform exactly to the contours of the Townside and Cherokee Chief rear fenders. Available as sets of two in black and white.



### ENGINE BLOCK HEATER

Give yourself faster starts in cold weather — and faster engine and heater warm-up — with this electric Engine Block Heater. The engine heater operates on regular 110-120 volt house current. Quicker starts save wear and tear on both engine and battery — a must in cold climates.



### CHROME TRUCK RAILS

Add a bit of distinctive styling and practicality to your Jeep pickup with these Chrome Truck Rails. Each rail is secured at 3 points by sturdy metal stanchions and provides an easy means for tying-down light cargo or tarpaulins. Chrome Truck Rails are available on all Jeep Trucks (Cannot be installed with roll bar or load binder.)



# Comfort, Appearance, Luxury

Everybody has their own style . . . so does every Jeep vehicle. And, you can "pick and choose" from our list of factory designed Accessories and Special Equipment until your Truck, Cherokee, Wagoneer or CJ is styled and appointed just the way you want it. Why not match your Jeep vehicle to your unique style . . . you deserve it!

	<b>Page</b>
Air Conditioning (All models) . . . . .	18
Air Deflector (Cherokee and Wagoneer) . . . . .	19
Bumper Guards (All models except CJ) . . . . .	23
Carpeting (All models except Truck) . . . . .	21
Chemicals, Appearance and Maintenance (All models) . . . . .	23
Cruise Control (All models except CJ) . . . . .	21
Decals (All models) . . . . .	23
Door Edge Guards (All models except CJ) . . . . .	23
Floor Mats (All models) . . . . .	20
Heavy-Duty Cooling System (All models) . . . . .	18
Highback Bucket Seats (CJ's only) . . . . .	21
Litter Container/Tissue Dispenser (All models) . . . . .	20
Luggage Carrier (All models except CJ) . . . . .	19
Luggage Rack (Cherokee and Wagoneer only) . . . . .	19
Mirrors (All models) . . . . .	22
Power Steering/Power Brake Kits (All models) . . . . .	23
Radio's (All models) . . . . .	20
Rear Seat (CJ-5 only) . . . . .	21
Slotted Wheels (All models) . . . . .	22
Spare Wheel Lock (All models) . . . . .	23
Sun Roof (CJ with Lexan top only) . . . . .	19
Tire Carrier, inside Spare (Cherokee and Wagoneer only) . . . . .	21
Vent Shades (All models except CJ) . . . . .	19

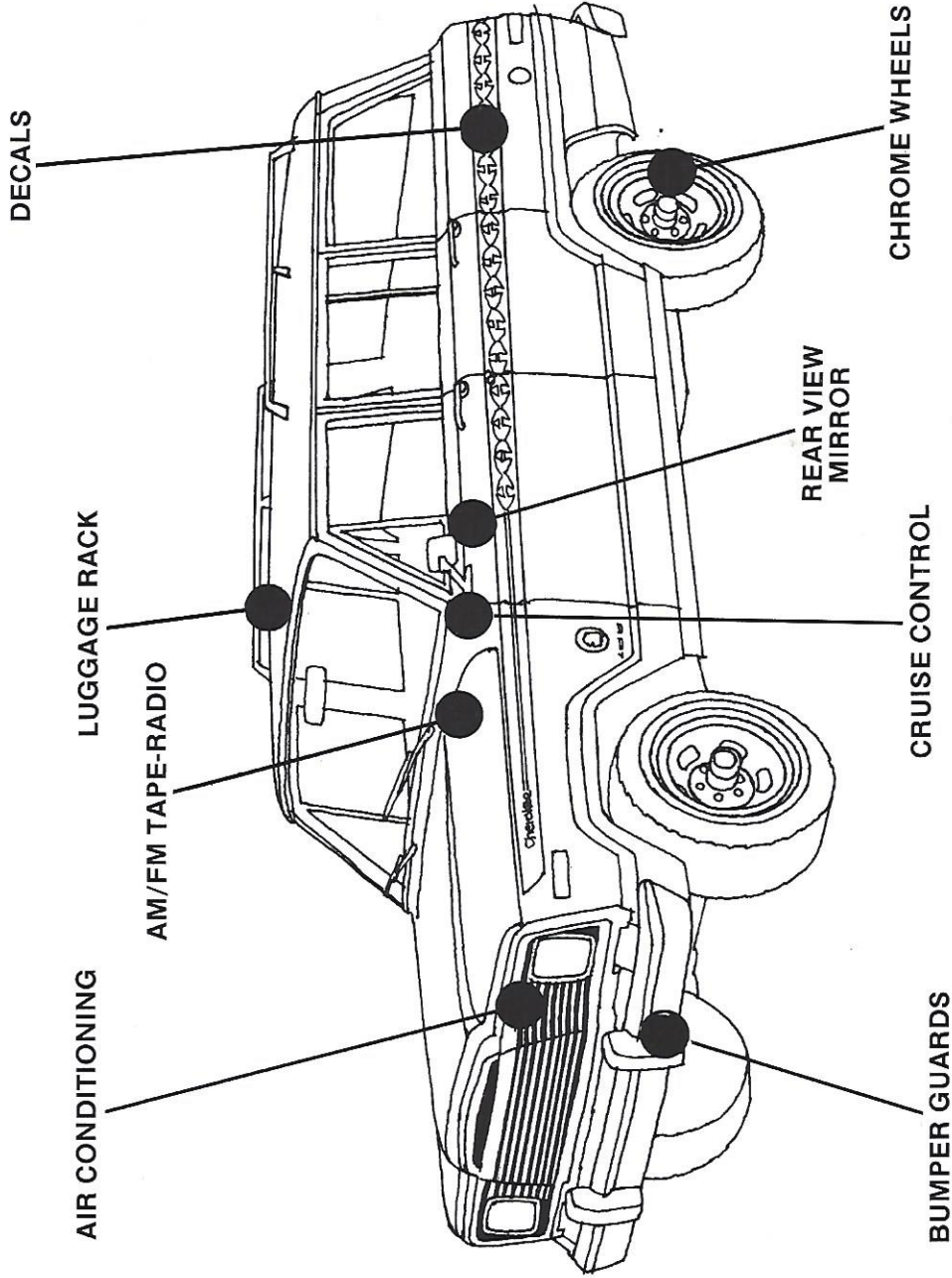

Special Equipment and Accessories . . .  
Engineered to Jeep® Quality Specifications



## American≡Air®

The only dealer installed Air Conditioning with the Jeep factory warranty . . .



### Custom American≡Air®

Relax and travel in comfort with our Custom American Air unit. Specifically designed for Jeep Trucks, Cherokee and Wagoneer models. The system features air volume and temperature controls with fully adjustable louvers for comfort conditioning to suit your taste. Heavy-Duty Cooling System and Adapter Kits required with Custom American Air.

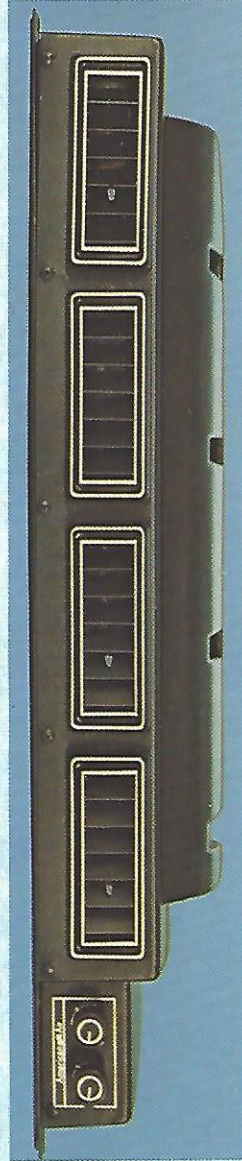

### American≡Air®

The CJ American Air system features high volume discharge ports that are fully adjustable, and dehumidify automatically. Designed specifically for CJ models, this under-the-dash system provides plenty of legroom for both driver and passenger. Heavy-Duty Cooling System and Adapter Kit required.

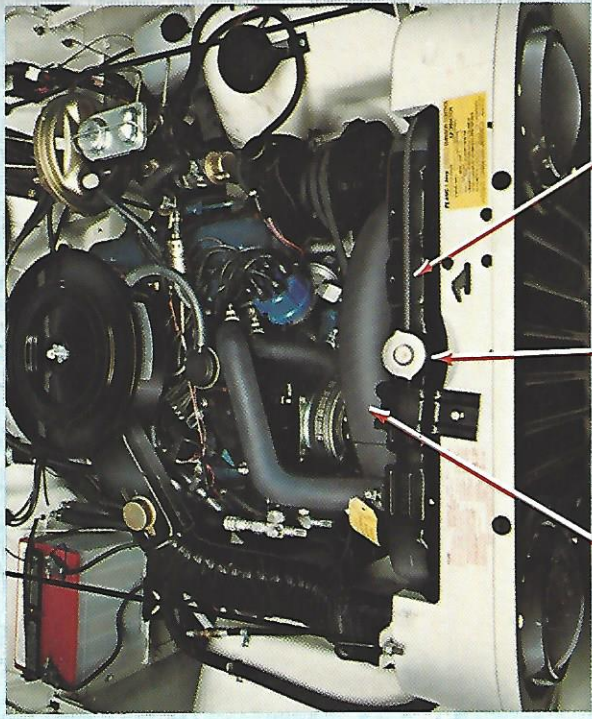
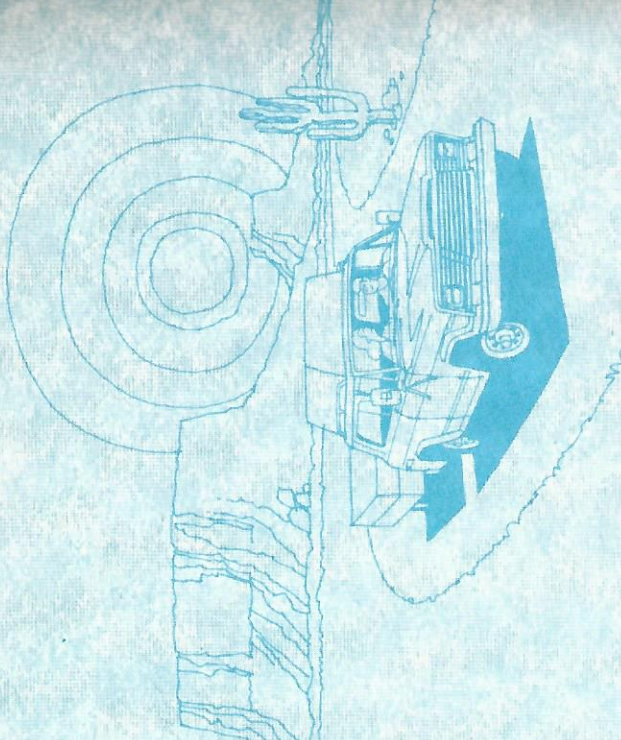

7 Blade Fan

Extra Capacity Radiator

Viscous Fan Drive (V-8)

### HEAVY-DUTY COOLING SYSTEM

The Jeep Heavy-Duty Cooling System is ideally suited to trailer-ing, off-road and heavy-hauling situations. This system features oversized radiator, radiator shroud and a special high-air-volume fan for extra engine cooling capacity. Required equipment with Air Conditioning, the Heavy-Duty Cooling System takes engine heating overloads right in stride.





**JEEP SUN ROOF  
(FOR LEXAN TOPS ONLY)**

Let us help you let the sun shine in with this high quality removable sun roof. Enjoy fresh air and sky through the large 18" x 33" opening size. You have your choice of completely removing the window or having it partially opened to 8-1/4". The tinted safety glass is framed by corrosion resistant aluminum. Available for CJ models with Lexan Top.



**VENT SHADES**

Attractive Jeep Vent Shades let you keep your windows open for fresh air even when the weather is bad. And, they add a bright touch to your Jeep Truck, Cherokee or Wagoneer. (Not available on CJ Models.)

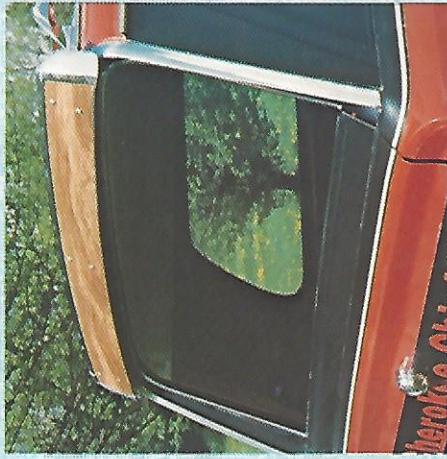

**REAR WINDOW AIR DEFLECTOR**

Designed to direct a steady stream of air across the rear window of your Cherokee and Wagoneer, and help to keep it clean. Prevent dust from entering, and aid ventilation. It's a touch of style! It is made of handsome chrome and woodgrain trim and can be used with any roof rack.

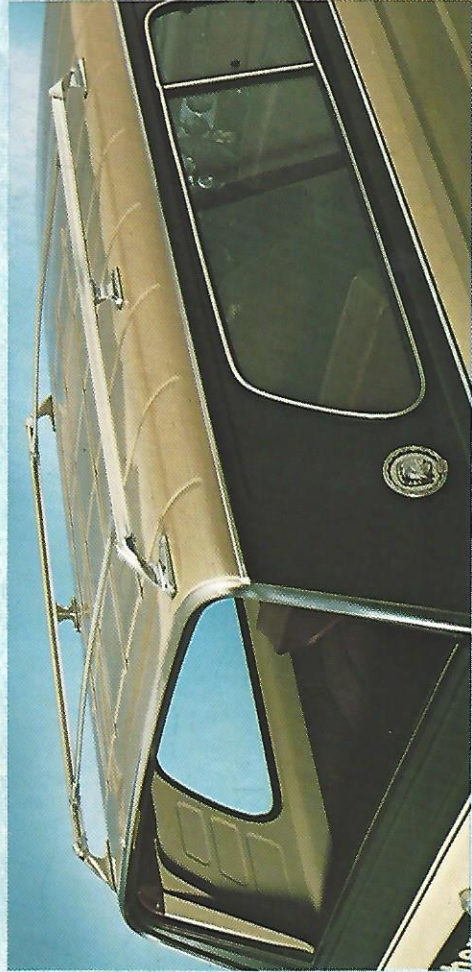

**LUGGAGE RACK**

When you run out of room it's practical to take full advantage of the load bearing capabilities of your Cherokee or Wagoneer with this attractive and sturdy Luggage Rack. The Luggage Rack is made of a bright finish metal which provides good looks and corrosion resistant practicality. It's ideal for hauling luggage and camping equipment.



**LUGGAGE CARRIER**

Water-proof vinyl cover over a hardboard floor and rugged frame provide extra capacity and protection for luggage or sports equipment. This durable carrier is ideally suited for travel and recreation. Available for Cherokee and Wagoneer.



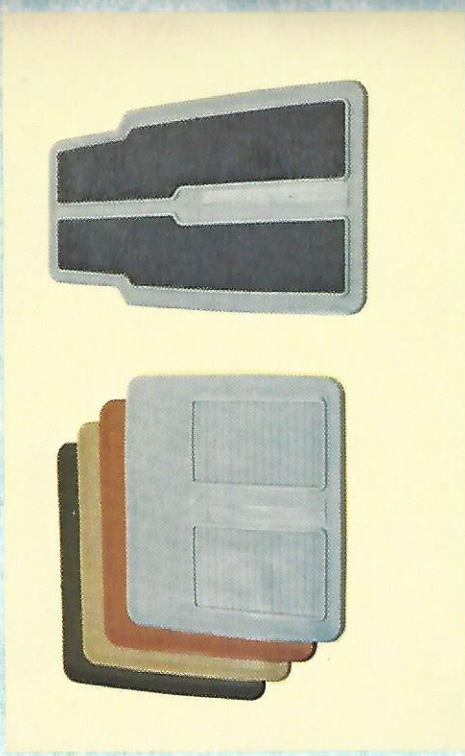

#### FLOOR MATS

Long wearing, colorfully attractive floor mats protect your vehicle's floor and carpeting the year 'round. Front mats feature a handsome carpeted insert. Color keyed to match your vehicle's interior colors. Rear mats are all rubber. Specify front, rear or both. Available in Black, Blue, Russet or Dark Desert Tan. (In Canada, sold in a package of front and rear sets.)

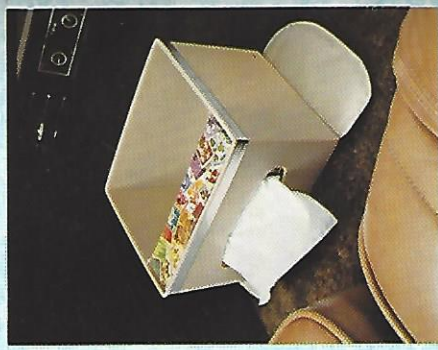

#### LITTER CONTAINER/TISSUE DISPENSER

Keep Jeep Country as well as your neighborhood free of litter with this convenient Litter Container/Tissue Dispenser. Keep a tissue close at hand for quick emergencies while driving. Weighted base helps prevent the container from tipping-over. Your choice of several colors.

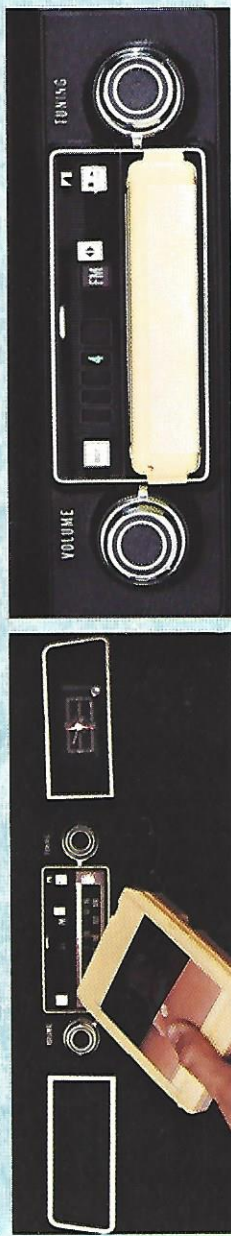
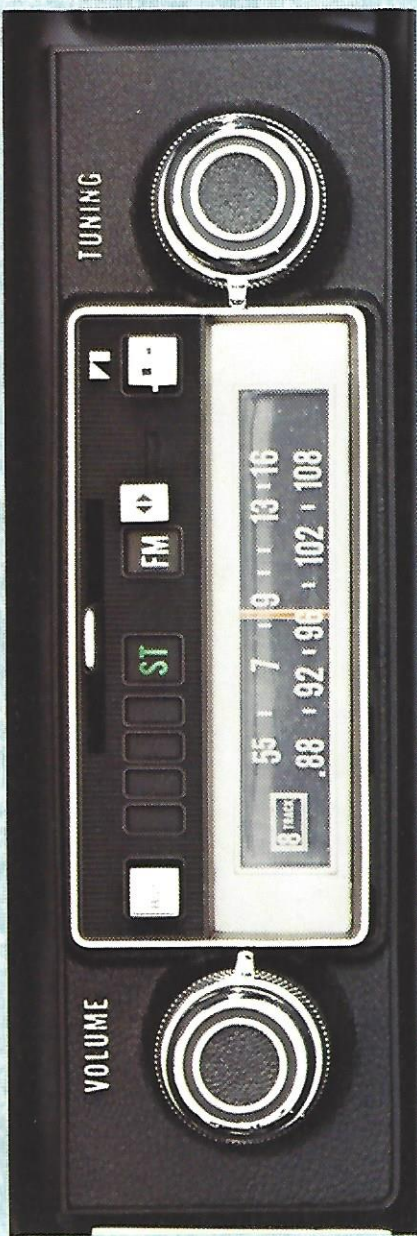

#### AM/FM MULTIPLEX/8-TRACK TAPE ENTERTAINMENT CENTER

Choose what you want to hear in stereo sound. You can select AM radio, FM Multiplex stereo or 8-track stereo tape entertainment at the touch of your hand. The unit features manual tuning in both AM and FM modes, stereo balance control, a FM indicator light, and flush-mounted front door speakers. Rear door speakers are also available. (Not available on CJ models.)

#### AM/FM MULTIPLEX RADIO (Not Shown)

When you want quality sound, you want our AM/FM Multiplex Radio. It provides superior stereo reproduction with features such as: manual station selection, stereo balance control and an FM indicator light for accurate tuning. Flush-mounted front door speakers are included and flush-mounted rear door speakers are available. (Not available on CJ models.)



#### AM/FM MULTIPLEX/CB TRANSCEIVER

The beauty of stereo sound entertainment and Citizens Band communications are combined in this specially designed in-dash transceiver. The CB section features 40 channel selection, squelch control, RF gain and noise limiting circuitry. The AM/FM Multiplex section features five pushbutton station selectors for AM and FM, as well as manual tuning, stereo balance control, a FM indicator light and flush-mounted front door speakers. The unit is available on Jeep Pickups, Cherokee and Wagoneer models.





### REAR SEAT

Distinctively styled and custom tailored rear seat. Available in Black or Flax vinyl. For all CJ models.



### INSIDE SPARE TIRE CARRIER

This custom designed spare tire carrier fits right inside your Cherokee or Wagoneer model. Reducing the chance of theft, while permitting you easy access to your spare tire.

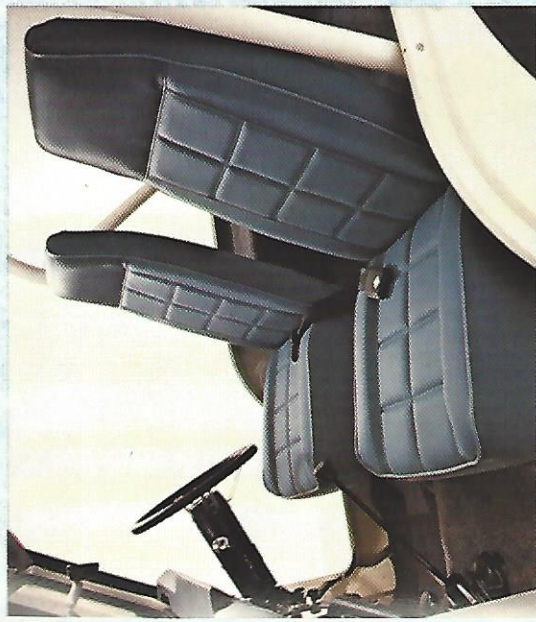

### HIGH BACK BUCKET SEATS

In 1979, you can select High Back Bucket Seats approved by Jeep. Add style and comfort to your Jeep CJ. New seats feature the patented-Perm-eze™ Flex-O-Lation™ back support system made of horizontally and vertically intertwined rubber coated wire connected to the seat frame — providing the support you prefer for even the longest trips.

The seats are all constructed with polyurethane foam padding, covered in a heavy duty stain-resistant woven vinyl fabric for practicality and durability. They are available in Black, Tan and Blue, on all CJ models.



### CRUISE CONTROL

Make those long expressway stretches easy on yourself. Select the desired speed over 30 mph, set the control, and Cruise Control keeps you at that speed until you touch the brake pedal. Cruise Control helps save on gas as well as the driver. (Not available on CJ models.)

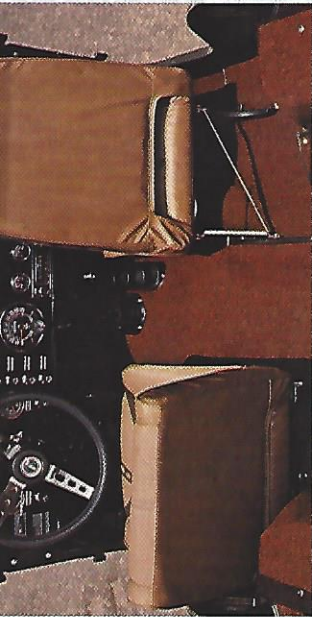

### FLOOR CARPETING

Custom designed carpets add that finishing touch to your CJ. Adds comfort and deadens road noise. Can be removed easily for cleaning. Scrub, vacuum or hose down. Resists fading and mildew. Designed for tough wear. Available in Brown and Charcoal.



### WHEELHOUSE CARPETING

CJ Wheelhouse Carpeting is designed to complement your CJ Floor Carpeting, and it adds an extra touch of good looks too. It is also available in Brown or Charcoal.



### CARGO AREA CARPETING

Long wearing, tough, snap-in cargo area carpeting is available for Cherokee and Wagoneer models. The carpeting is made of durable olefin indoor-outdoor material and adds to your comfort by insulating and reducing road noise. Available in Charcoal.

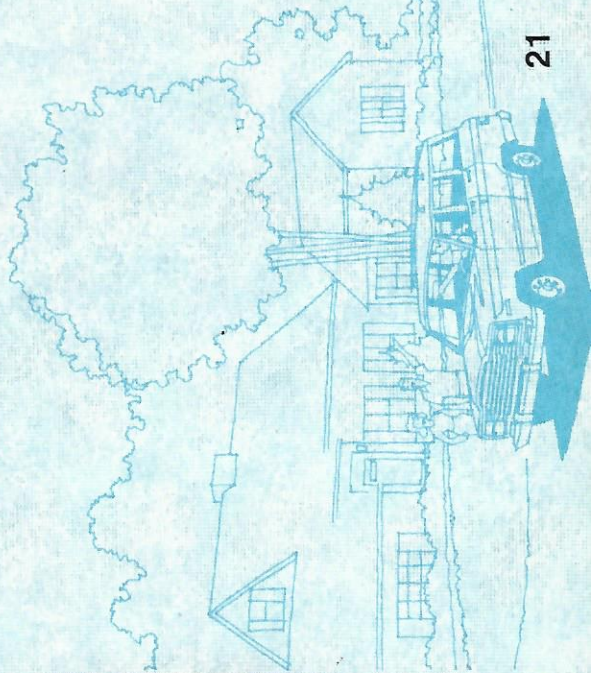





**TRIPOD SUPPORT MIRROR**

Large visibility and rear viewing are provided for by this 6-1/2 x 9-1/2" mirror. The mirror mounts below eye level for greater viewing comfort and features vibration-free tripod mounting. Available on all Jeep models, the mirror is finished in bright chrome for lasting good looks.

**MIRROR EXTENSIONS**

Double the use of your tripod type mirror for trailer hauling with these mirror extensions. They extend your mirrors four inches to improve rear viewing when carrying camper bodies or pulling a trailer.

**JUNIOR WEST COAST MIRROR**

Big rear visibility lets you see what you want without regard to "dead" spots. All Angle, 5-1/4" x 10-1/2" is easily installed. Finished in silver-grey.



**OUTSIDE REAR VIEW MIRROR**

Available on Cherokee, Wagoneer and Pickup models. Good-looking, chrome-plated mirror can mount on either the right or left door providing a viewing area of 3-3/4 x 5-1/2".

**SLOTTED WHEEL. 8"**

Designed and engineered for Jeep vehicles, this slotted wheel features eight-spoke design and mated wheel and disc for maximum load capacity and endurance. The wheel is finished in white epoxy with a red pin-stripe. Available for CJ models in a five bolt pattern and wide wheel Cherokee and Truck in a six bolt pattern.



**CHROME SLOTTED WHEEL. 7"**

Finished in bright chrome, this version of the slotted wheel offers the same durability and load-carrying versatility as the epoxy-finished wheel, but adds a custom look. The wheel is available in a six bolt version only.







#### DOOR EDGE GUARDS

Protect your Cherokee, Wagoneer or Truck from unsightly chips and nicks. They're easy to install and complement body style. (Not available on CJ models.)



#### DECALS

Customize your Jeep vehicle with Decals. You can add your own personal touch of style. Choose from several decal designs or see your Jeep dealer for his expertise.

#### POWER STEERING KIT (Not Shown)

Reduce steering effort and driver fatigue. Install our Power Steering Kit and let your fingers do the turning.

#### POWER BRAKE KIT (Not Shown)

Power Brake Kits help decrease effort and reduce stopping distance for an extra margin of safety. It is fully covered by the Jeep factory warranty, and is easily installed.

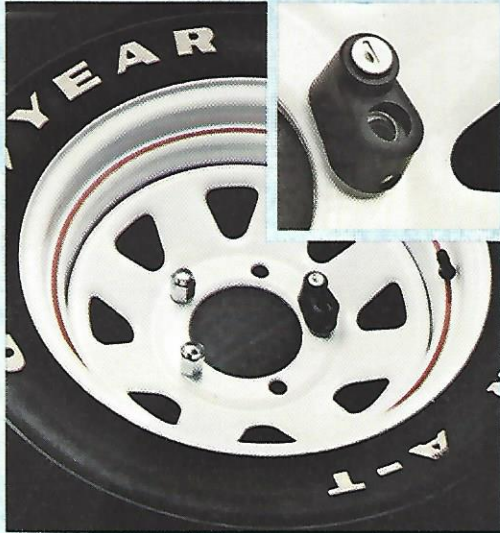

#### SPARE WHEEL LOCK

Guard your spare tire and wheel with this heavy-duty spare wheel lock. Finished to help prevent rust, this lock is available for all Jeep vehicle wheels. Features tamperproof key locking.



#### BUMPER GUARDS

Newly styled for '79, Jeep Bumper Guards protect your Cherokee, Wagoneer or Pickup from dings and dents caused by parking accidents and mild front and rear end impacts. (Not available on CJ models.)



#### APPEARANCE AND MAINTENANCE CHEMICALS

Our complete line of cleaners, waxes, polishes and touch-up paints are specially formulated to preserve the original beauty of your Jeep vehicle. Our engine chemicals guard against wear to improve performance and operation which in turn improves engine life. Protect your investment with the chemicals approved by the company who made your vehicle . . . JEEP CORPORATION!

(In Canada illustrated product may be different.)

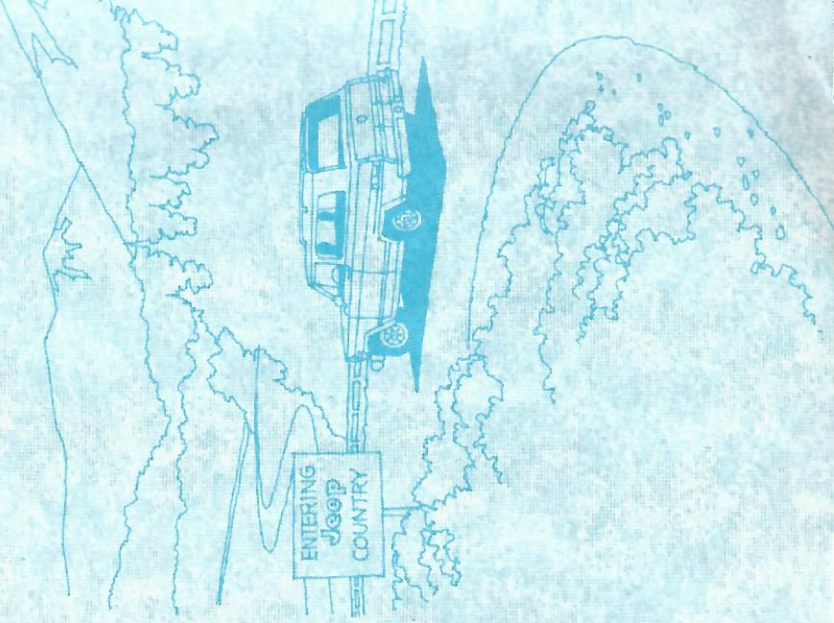



Compliments of:

## Who Knows More About Servicing Your Jeep® Vehicle Than A Jeep Dealer?

Nobody! Jeep mechanics are factory trained using the latest equipment and servicing techniques. They know how to take care of your Jeep vehicle — it's their job and they're good at it. They use only factory approved parts — installed according to approved procedures — to

help maintain the reliability you bought when you bought a Jeep product. And, all Jeep Special Equipment and Accessories installed by the Dealership on a new Jeep vehicle prior to owner delivery are covered by the 1979 Jeep New Vehicle Limited Warranty.

### SPECIAL EQUIPMENT LIMITED WARRANTY

The following limited warranty applies to Jeep Corporation Special Equipment: Jeep Corporation\* warrants to the vehicle owner that for 12 months or 12,000 miles (whichever comes first) (in Canada, 12 months or 12,000 miles/20,000 kilometers, whichever comes first) from the documented date of sale and installation any authorized Jeep dealer will, at no charge, repair or replace any new Jeep Corporation approved Special Equipment, sold and installed by any authorized Jeep dealer which proves defective in material or workmanship.

Jeep Corporation\* warrants to the original retail purchaser that, for 12 months or 12,000 miles (whichever comes first) (in Canada, 12 months or 12,000 miles/20,000 kilometers, whichever comes first) from the documented date of sale, any authorized Jeep dealer will, at no charge other than the cost of removal and installation, repair or replace any new Jeep Corporation approved Special Equipment sold without installation by any authorized Jeep dealer which proves defective in material or workmanship.

No other express warranty is given or authorized by Jeep Corporation. Jeep Corporation disclaims any implied warranty of MERCHANTABILITY or FITNESS for any period beyond the express warranty, and shall not be liable for loss of use of vehicle, loss of time, inconvenience, or other incidental or consequential damages. Some states or provinces do not allow limitation or exclusion of incidental or consequential damages, or limitations on how long an implied warranty lasts, so the above exclusion and limitation may not apply. This warranty gives specific legal rights, and the retail purchaser or vehicle owner may also have other rights which vary from state to state or province to province. \*In Canada: American Motors (Canada) Limited.

Jeep®, CJ, CHEROKEE, GOLDEN EAGLE, QUADRA-TRAC®, RENEGADE® and WAGONEER® are trademarks of Jeep Corporation.  
American Motors (Canada) Limited is a licensed user. © Reg. TM

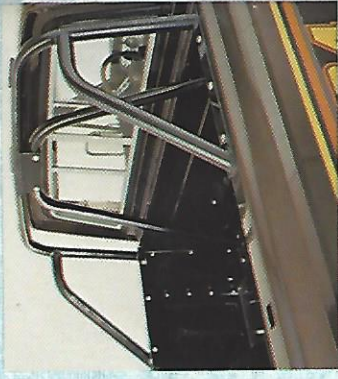

Equipment and features illustrated or described in this catalog are optional at extra cost unless otherwise specified. Certain equipment items may not be available for all models. All information contained herein was obtained from official sources and, to the best of our knowledge, is correct at the time of publication. Jeep Corporation

reserves the right to revise, modify, discontinue or change specifications on any model, parts or accessories at any time without notice and without incurring any liabilities on its part or that of its dealers to the purchaser.

**PARTS DIVISION**  
 **American Motors**

PDS-6/78-63

Litho in U.S.A. Rev. 2/79